



SankyoTateyama



# Aluminum Exterior Products Series Catalog



Made in Japan

Aluminum exterior systems  
made in Japan



# INDEX

## Shade Solution

**MSD/MSK series**

▶ P.3

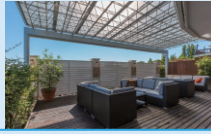

**USN series**

▶ P.5



**KWC series**

▶ P.7



**LJ series**

▶ P.9



**MLR series**

▶ P.11



**RSC series**

▶ P.13



**PJFF series**

▶ P.14



**PJR series**

▶ P.15



**PJF series**

▶ P.19



**VR/VRS series**

▶ P.27



**KLB/KLBS series**

▶ P.28



**ATLD series**

▶ P.29



**SKC series**

▶ P.31



## Outdoor Living

**TF/TR series**

▶ P.36



**NW series**

▶ P.38



**Outdoor Frame L-class**

▶ P.39



## Gate & Fence

**AGT series**

▶ P.42



**MCE series**

▶ P.43



**WM series**

▶ P.45



**CEF series**

▶ P.47



**SHR series**

▶ P.49



**ROF series**

▶ P.51



**NLB series**

▶ P.51



**HGN series**

▶ P.52



## Renovation Door

**NVR series**

▶ P.54





## ALUMINIUM COLOR

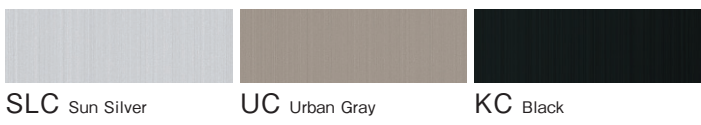

SLC Sun Silver

UC Urban Gray

KC Black

## ROOF COLOR

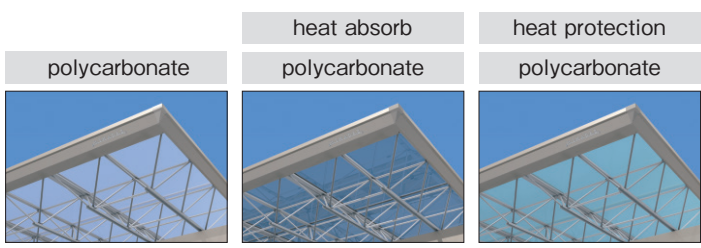

SI frosted

CL clear

H/P SI frosted

## Both side post stand

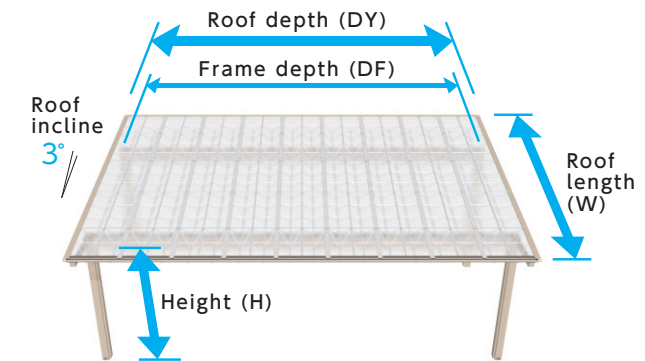

## Both side post stand roof size

	W	DY	27	36	45	54	63	72	81	90	99	108	117
Carport	49		○	○	○	○	○	○	○	○	○	○	○
	54		○	○	○	○	○	○	○	○	○	○	○
	58		○	○	○	○	○	○	○	○	○	○	○
Multi-roof	28		○	○	○	○	○	○	○	○	○	○	○



### MSD Series

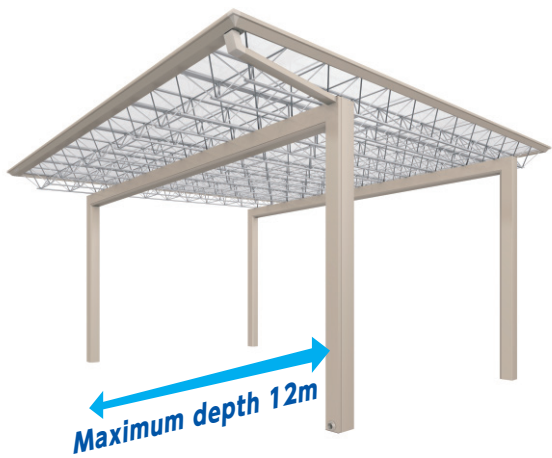

Both side post stand (wall attached)

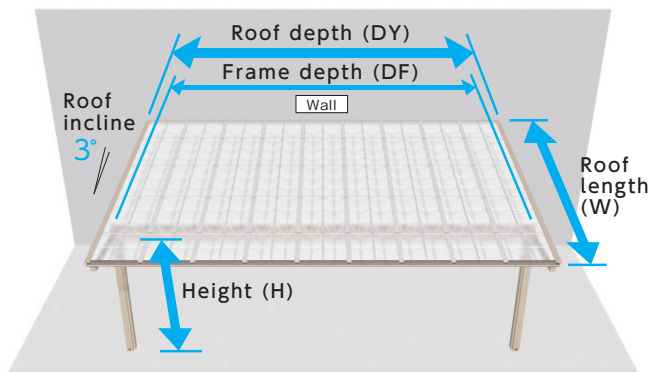

Both side post stand (wall attached) roof size

	W	DY	27	36	45	54	63	72	81	90	99
Carport	49	○	○	○	○	○	○	○	○	○	○
	54	○	○	○	○	○	○	○	○	○	○
	58	○	○	○	○	○	○	○	○	○	○
Multi-roof	28	○	○	○	○	○	○	○	○	○	○

### MSK Series

Hanging roof type

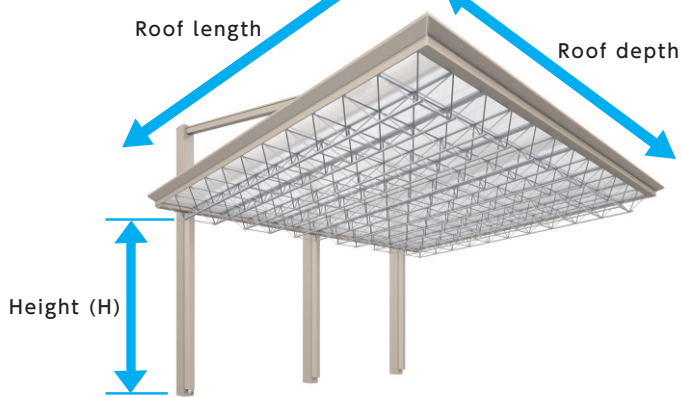

Cantilever type

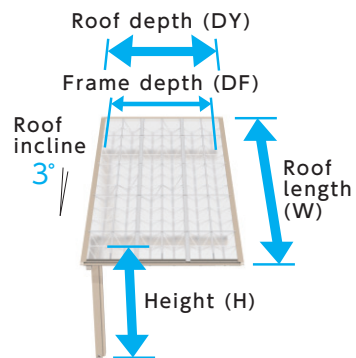

Cantilever type roof size

W	DY	18	27
49	○	○	○
54	○	○	○
58	○	○	○

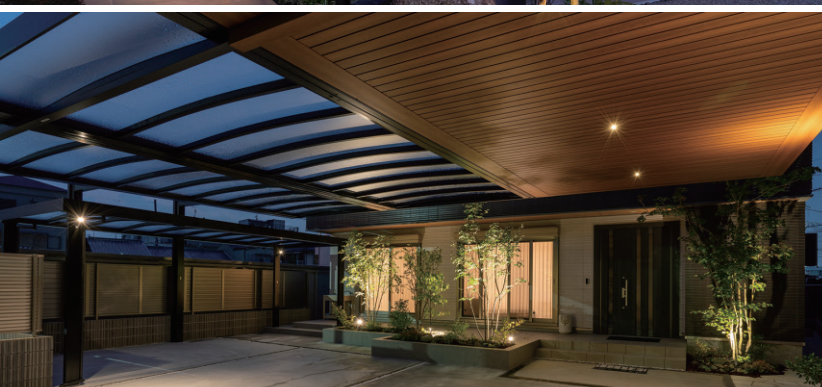

## ALUMINIUM COLOR / CEILING

aluminium type			laminated part			
SLC Sun Silver	UC Urban Gray	KC Black	FA Trad Oak	YC Craft Cherry	HG Bitter Grain	YN Silky Noche

## ROOF COLOR

heat protection			aluminium roof panel	
polycarbonate	polycarbonate		aluminium roof panel	
SI frosted	H/P A0 blue smoke	H/P SI frosted	UC Urban Gray	BD Dark Bronze



## Roof style variations

### Standard Roof

Aluminium roof frame

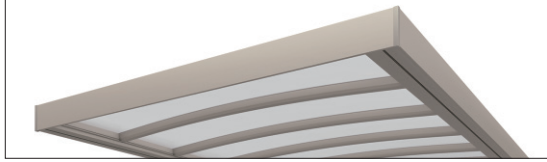

Wood-laminate roof frame



### Premium Roof

Aluminium roof frame + Wood-laminate ceiling

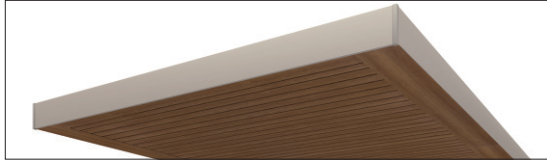

Wood-laminate roof frame + ceiling

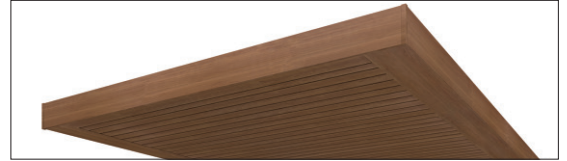

### Select-line Roof

Aluminium roof frame

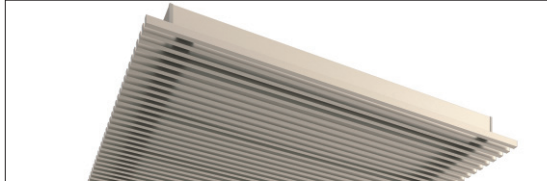

Wood-laminate roof frame + ceiling

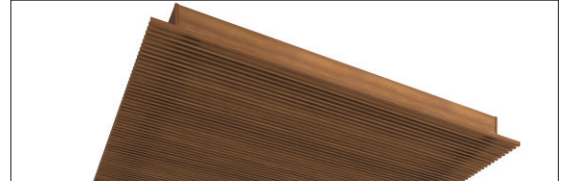

## Basic structure

Roof placed on beams



Roof suspended from beams



Pergola

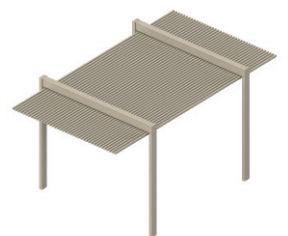

## Size (mm)

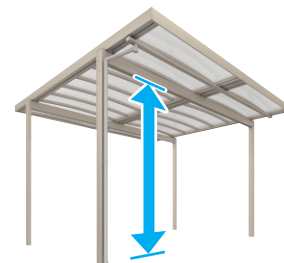
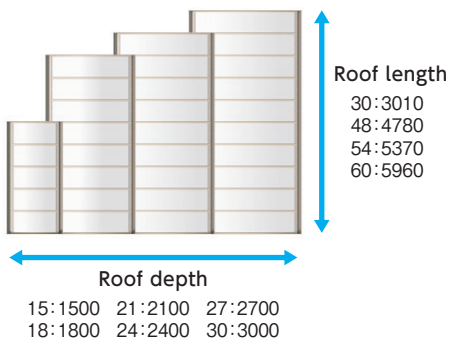

**Maximum beam height  
3.5m**

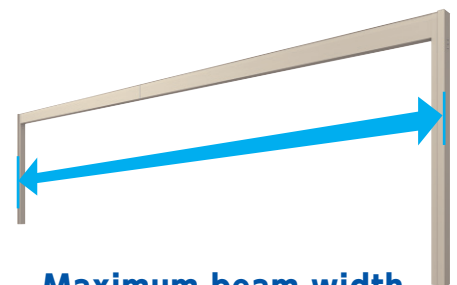

**Maximum beam width  
12m**

## Ceiling

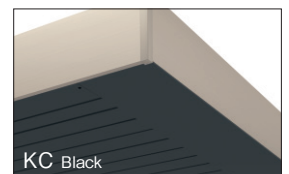



## ALUMINIUM COLOR

aluminium type			laminate type					
SLC Sun Silver	UC Urban Gray		FA Trad Oak	SLC Sun Silver	YC Craft Cherry	SLC Sun Silver	FA Trad Oak	UC Urban Gray
KC Black	KC Black	SLC Sun Silver	FAL		YCL		FAU	
KLC			YC Craft Cherry	UC Urban Gray	YC Craft Cherry	KC Black		
			YCU		YCK			

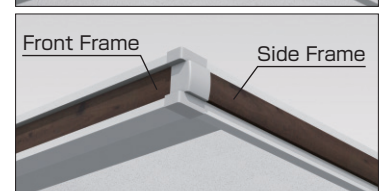
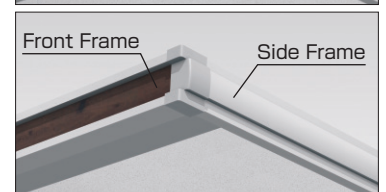
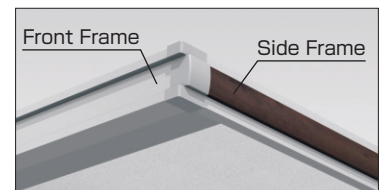

## ROOF COLOR

polycarbonate			black polycarbonate		silver polycarbonate		heat protection polycarbonate	
SI frosted	KP matt black	SSP matt silver	H/P AO blue smoke	H/P SI frosted				

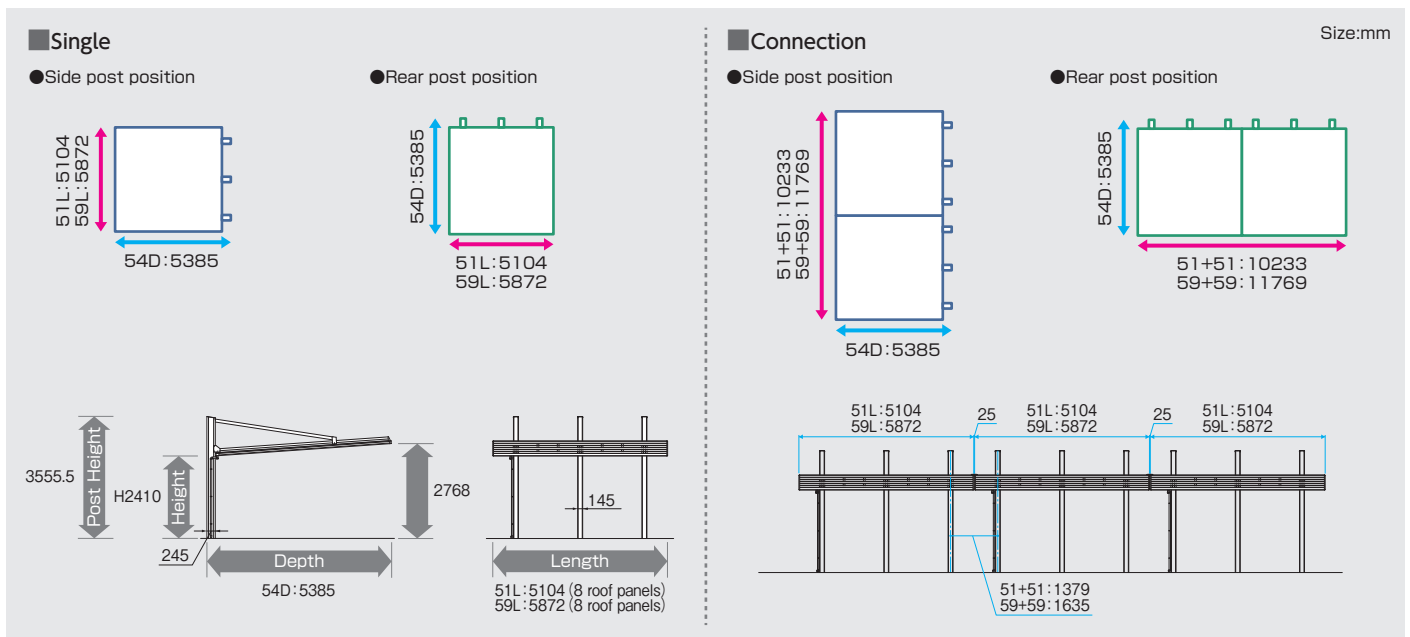



## ALUMINIUM COLOR



aluminium type

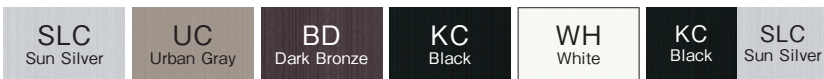

KLC



laminate type

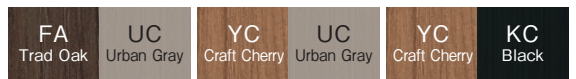

FAU

YCU

YCK

## ROOF COLOR

polycarbonate



AO blue tinted



SI frosted

black polycarbonate



KP matt black

silver polycarbonate



SSP matt silver

heat protection

polycarbonate



H/P AO blue smoke



H/P SI frosted



## Silver Polycarbonate Panel

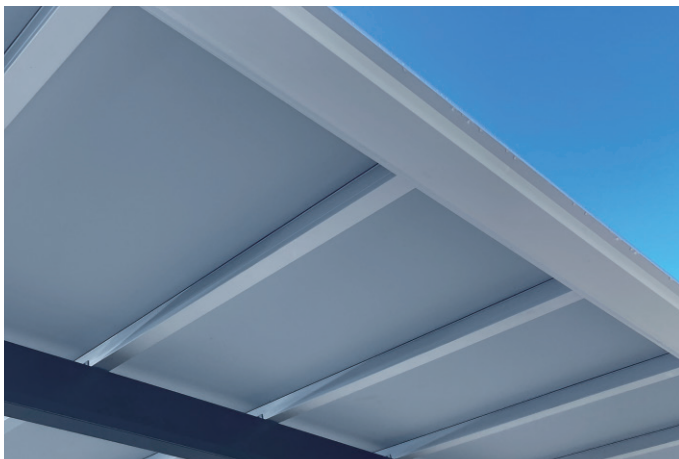

A new roof panel in a non-transparent, matt silver color is now available. It combines heat-shielding and light-blocking properties, making the space under the roof even more comfortable.

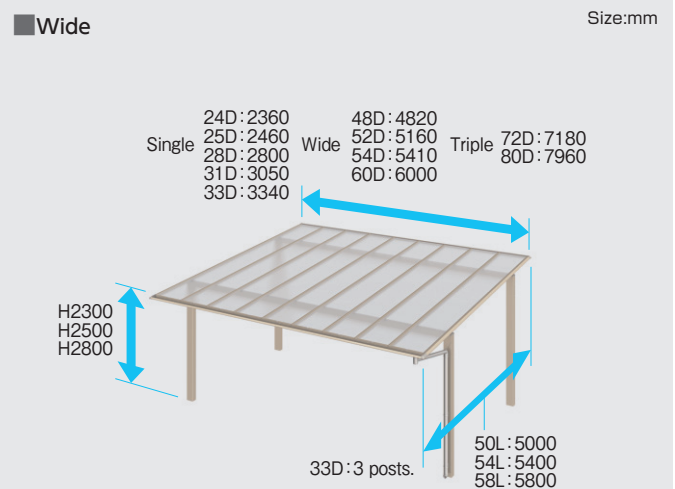



In-Line Connection

Y-Connection

In-Line Short Extension



**ALUMINIUM COLOR**

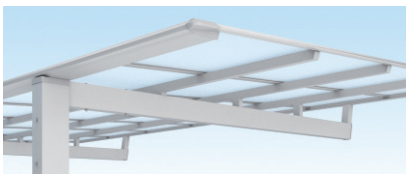

aluminium type

laminate type



FAL

YCL

FAU

YCU

**ROOF COLOR**

polycarbonate

black polycarbonate

silver polycarbonate

heat protection

polycarbonate

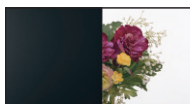

AO blue tinted

SI frosted

KP matt black

SSP matt silver

H/P AO blue smoke H/P SI frosted



## Reversible Roof Incline (Option)

● Standard Incline Roof Type

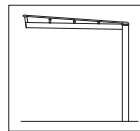

● Reverse Incline Roof Type

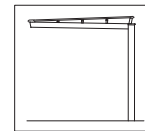

Reverse

### Single Basic

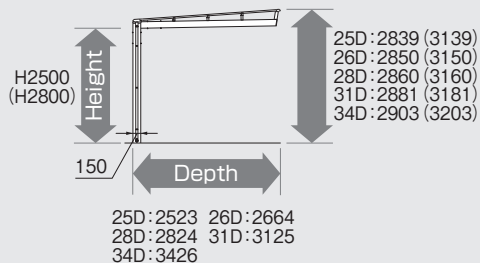

### M-Connection

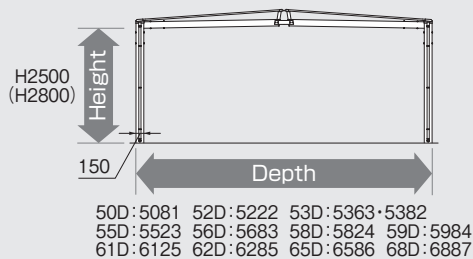

Size:mm

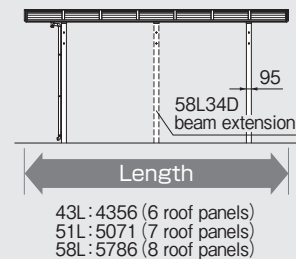

### Reverse Incline Roof

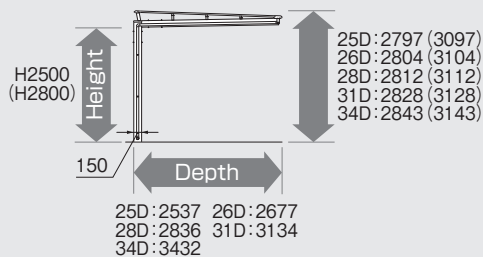

### Mini

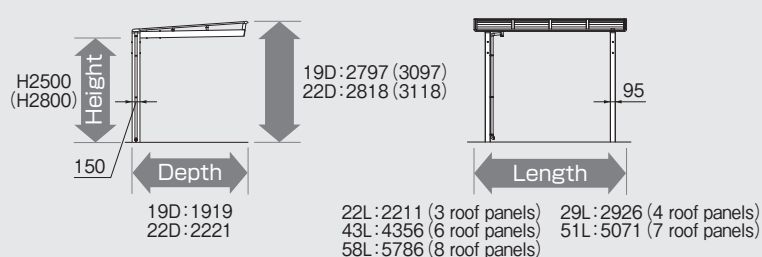



Wide



Multiple Connection



## ALUMINIUM COLOR

aluminium type

SLC  
Sun Silver

UC  
Urban Gray

KC  
Black

laminate type

FA  
Trad Oak

SLC  
Sun Silver

YC  
Craft Cherry

SLC  
Sun Silver

FAL

YCL

laminate type

FA  
Trad Oak

UC  
Urban Gray

YC  
Craft Cherry

UC  
Urban Gray

FAU

YCU

## ROOF COLOR

polycarbonate

heat protection

polycarbonate



SI frosted

H/P A0 blue smoke H/P SI frosted

### Single

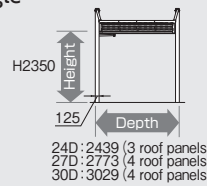

Size:mm

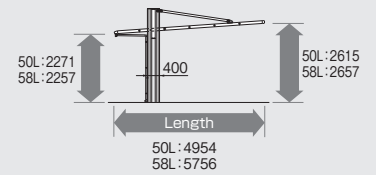

### Multiple Connection

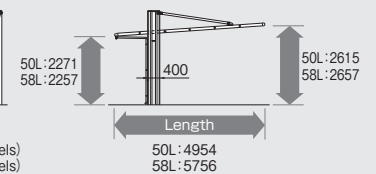
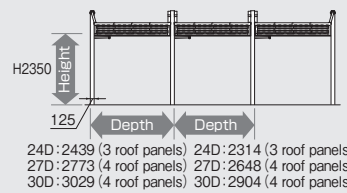

### Wide

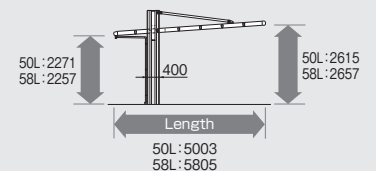
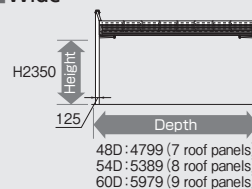



### ALUMINIUM COLOR

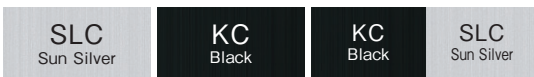

KLC

### ROOF COLOR

polycarbonate    black polycarbonate    silver polycarbonate



SI frosted



KP matt black



SSP matt silver

heat protection

polycarbonate



H/P SI frosted

#### Single

Size:mm

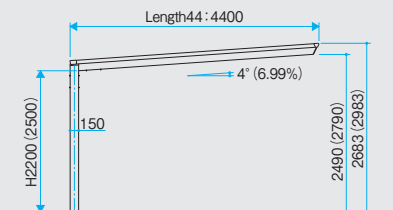
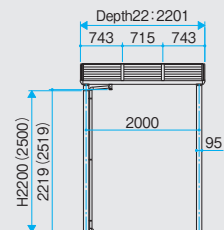

#### Depth Connection

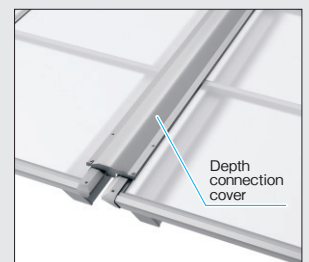
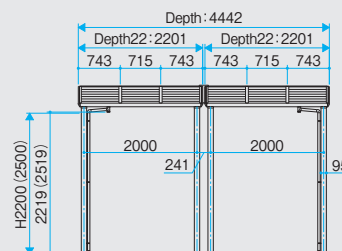



**ALUMINIUM COLOR**

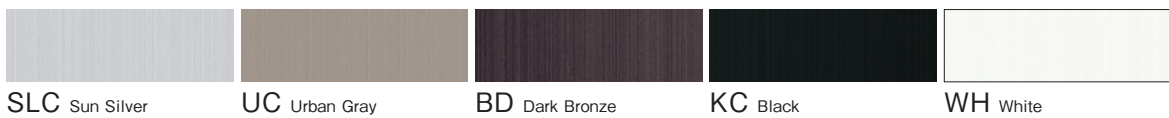

**ROOF COLOR**

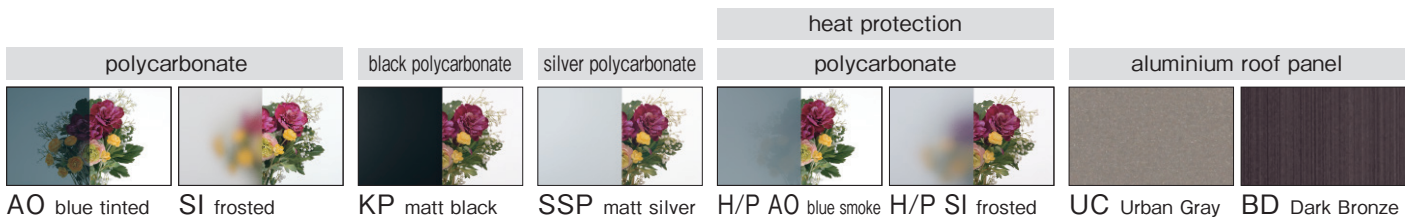

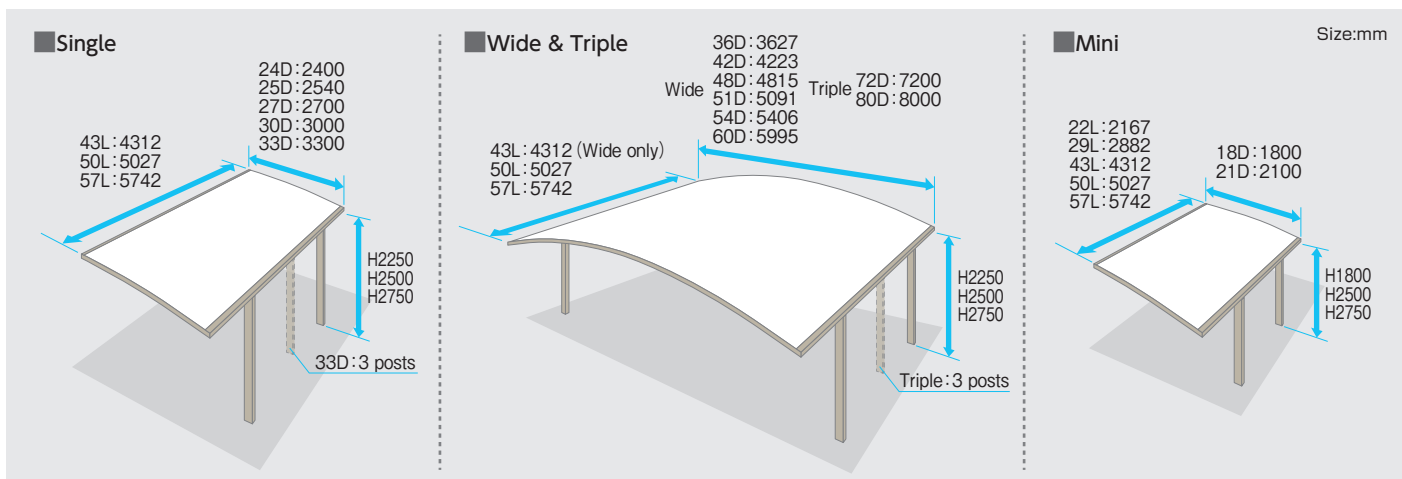



In-Line Connection

M-Connection

Single Basic



Single Basic

Wide Beam





M+Y Connection



Single Basic



# PJF series



M-Connection



Y-Connection



In-line Connection



## ALUMINIUM COLOR



SLC Sun Silver

UC Urban Gray

BD Dark Bronze

KC Black

WH White

## ROOF COLOR

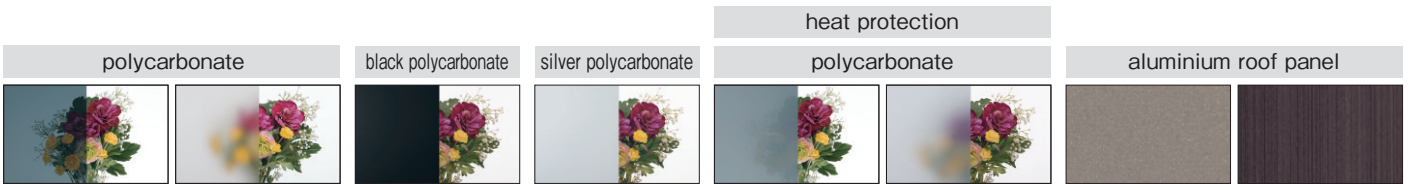

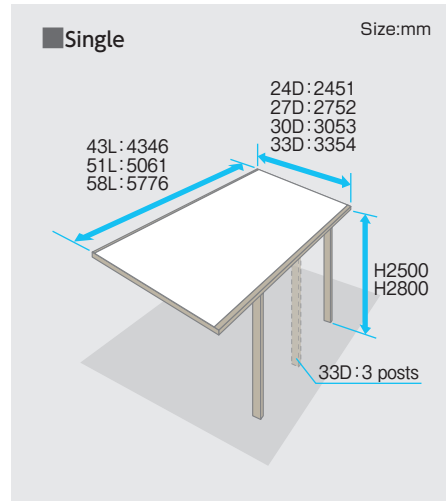
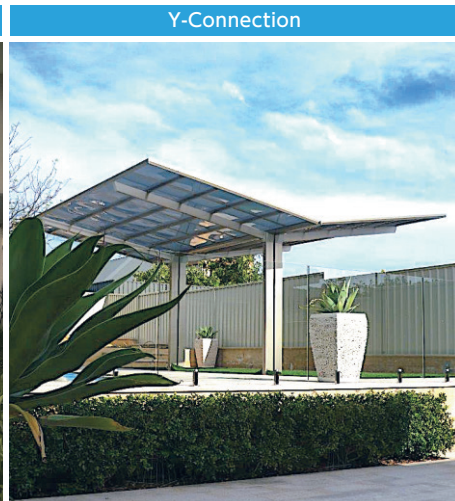
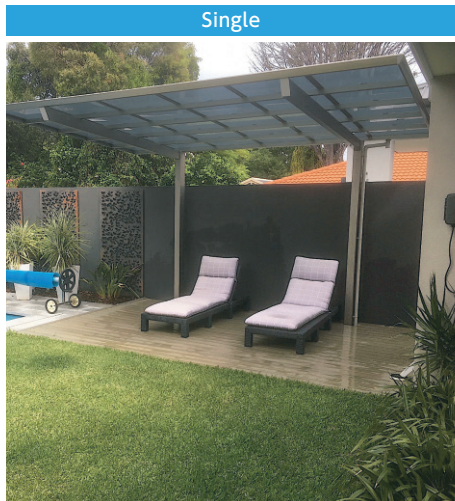



In-Line Connection

Single





Basic

In-Line Connection



# PJR / PJF Series Configurations

## CONFIGURATIONS PJR & PJF

Single Basic

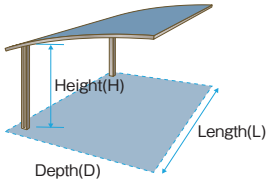

Wide Beam

(Continuous Beam not available with PJF series)

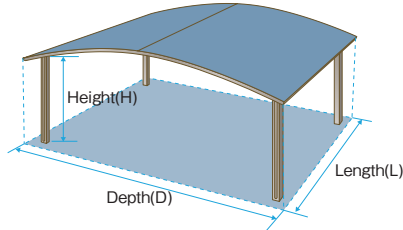

Y Connection

(2 x Single Units Back to Back)

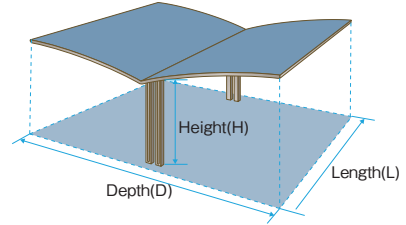

Inline Connection

(2 x Single Units End to End) Inline

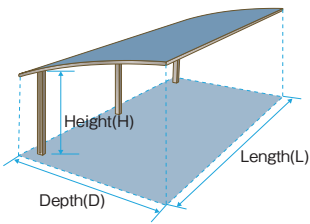

M Connection

(2 x Single Units Side to Side)

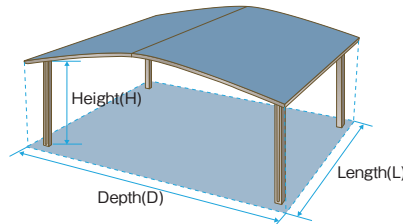

M+Y Connection

(3 x Single Units Configuration)

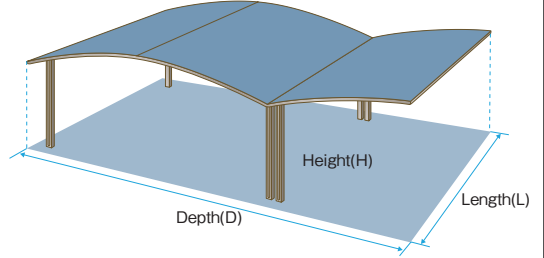

## PJR Series

Size:mm

Single Basic

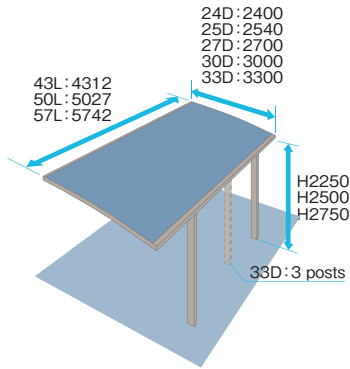

Wide & Triple Beams

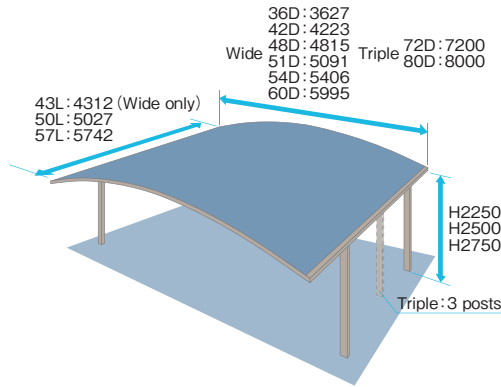

Mini

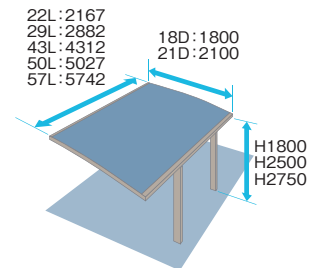

## PJF Series

Size:mm

Single Basic

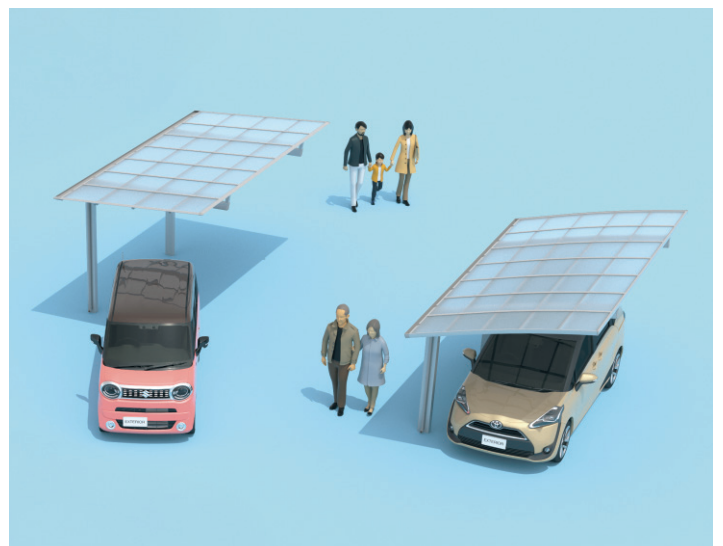
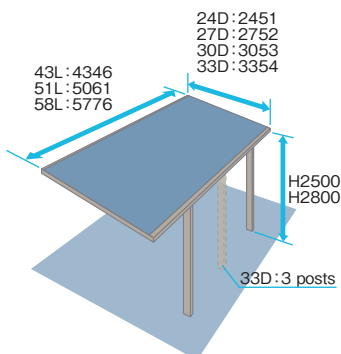

# PJR & PJF Series Common Features

## Size

**Wide** Max. depth 33D cantilever available now.

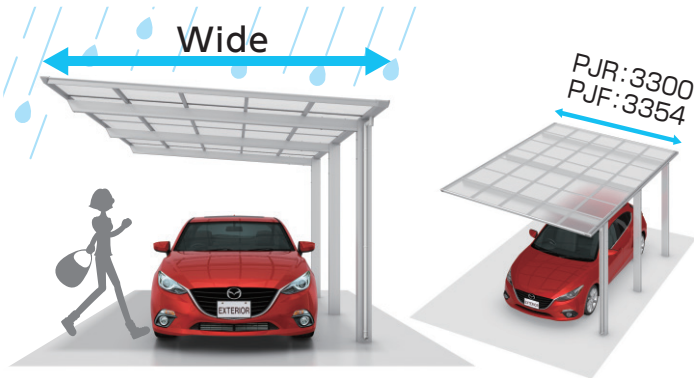

**Compact** Compact length 43L available now.

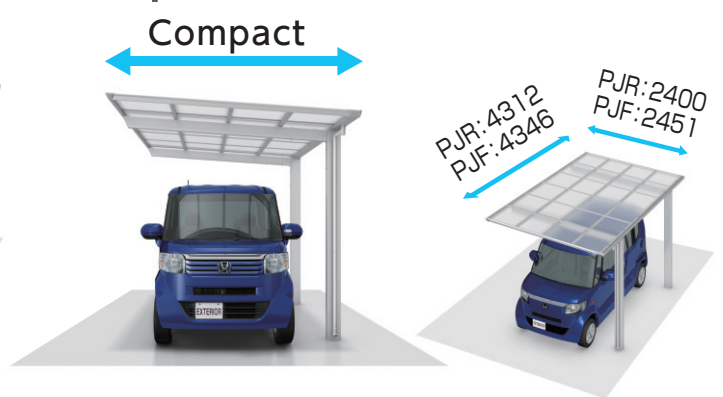

## Post Type

**PJR Series** 3 different long post types H23, H25, H28 are available.

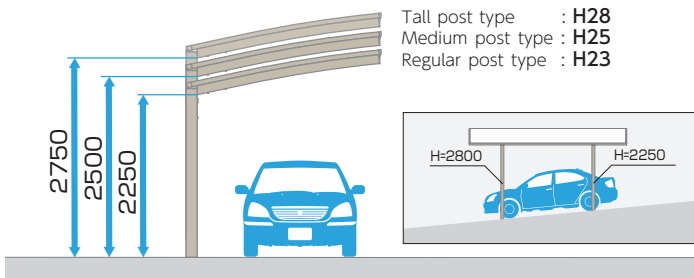

**PJF Series** 2 different long post types H25, H28 are available.

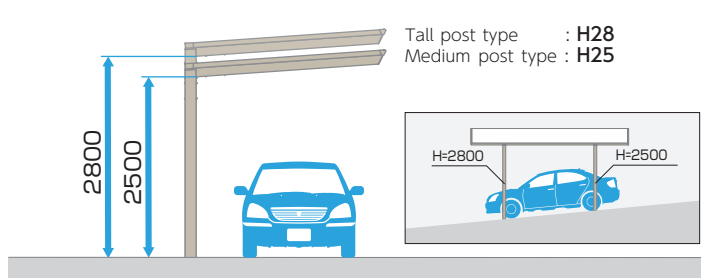

## Side Panel

**PJR Series**



**Notes-1** Not available for ports with tall posts H28 (H=2.8m).  
**Notes-2** Requires an additional support post for side panels higher than H800, and panel support to achieve higher wind rating.

**PJF Series**



**Notes-1** Not available for ports with tall posts H28 (H=2.8m).  
**Notes-2** Requires an additional support post for side panels higher than H800, and panel support to achieve higher wind rating.

## Locking Bolt

### Common Screws

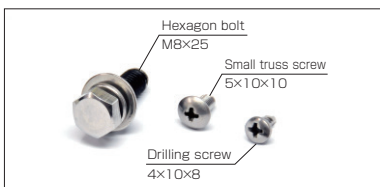

3 types of screws help save time during installation.

## Protect Cushion

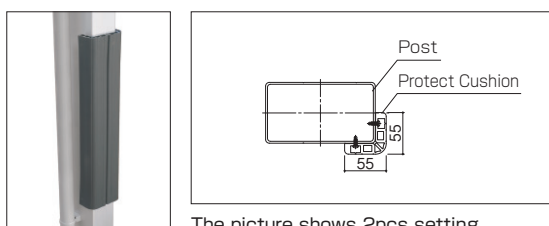

The picture shows 2pcs setting.  
 The rubber cushion protects car-door and post while getting in/out the car.

## Aluminium Down-spout

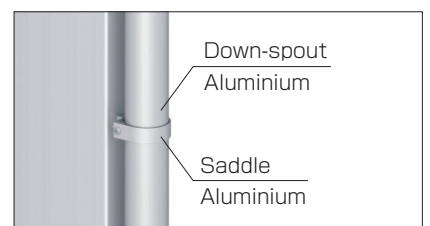

Aluminium rain gutter and saddle.

# Basic carport assembling guide



**Parts Box Components**

**2**

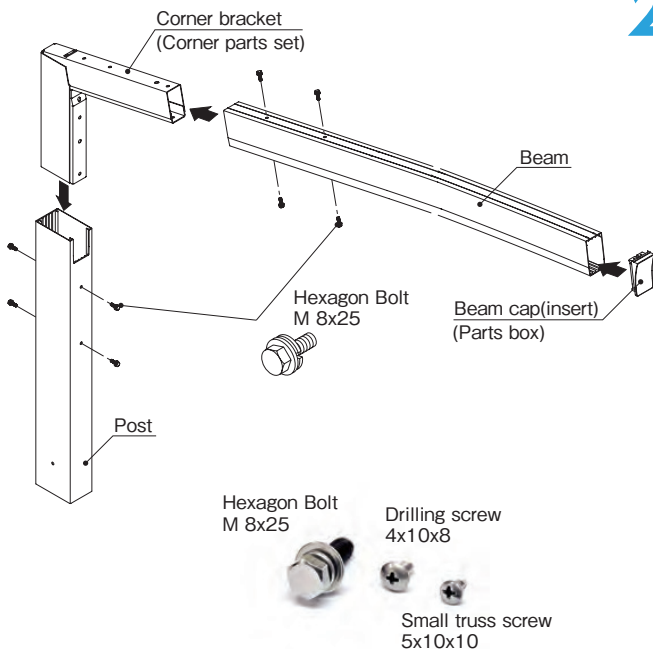

**Posts - Corner Brackets - Beam connections**

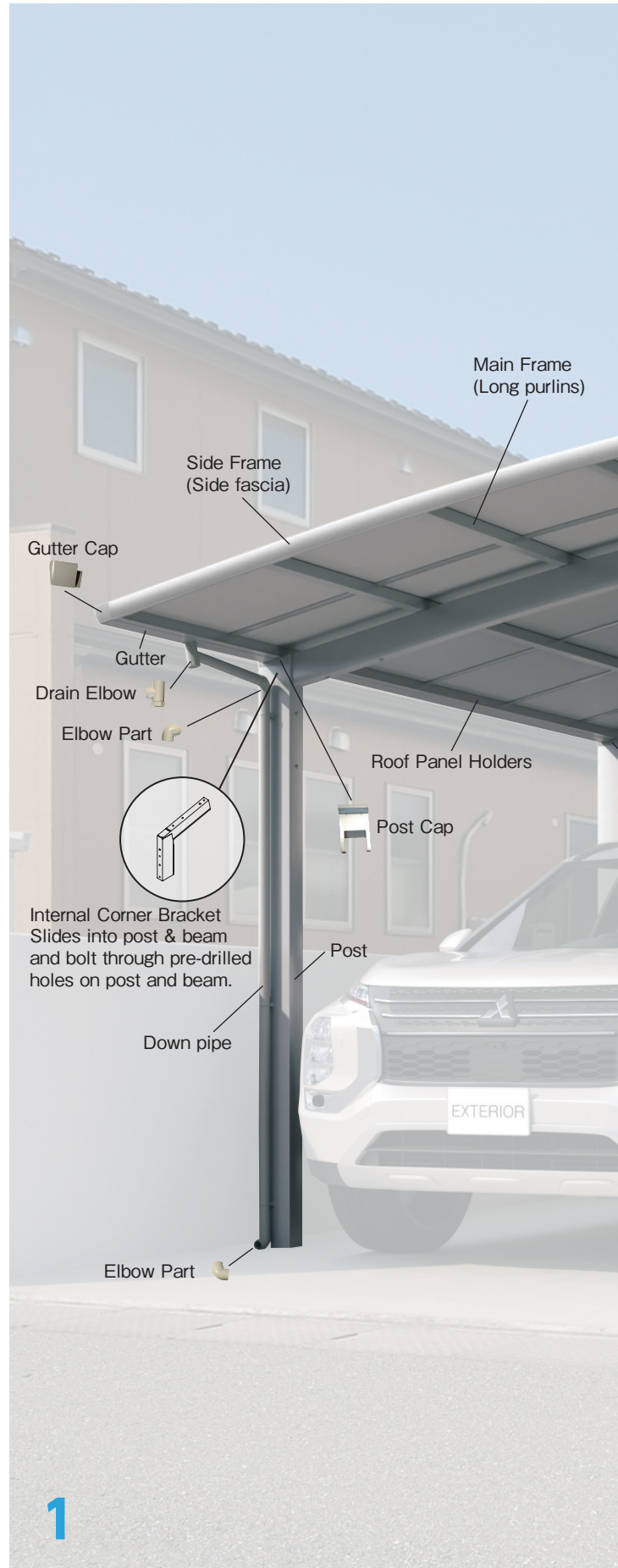

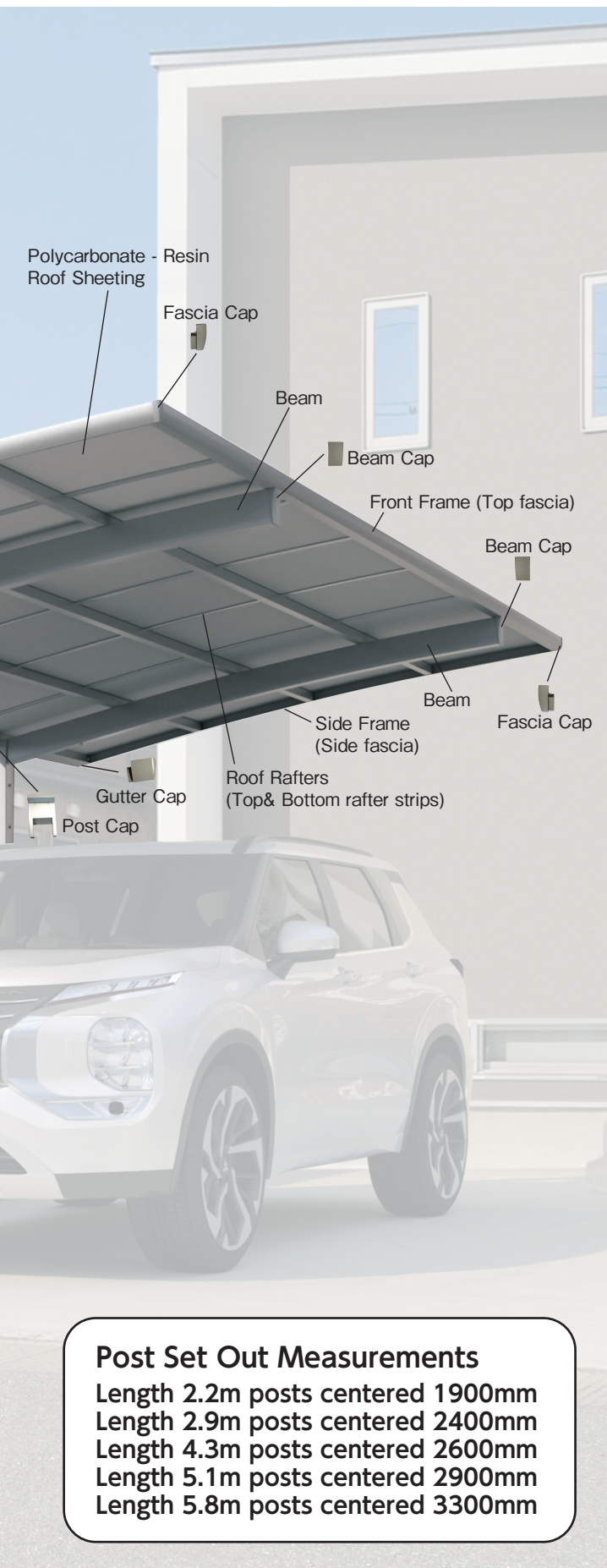

3

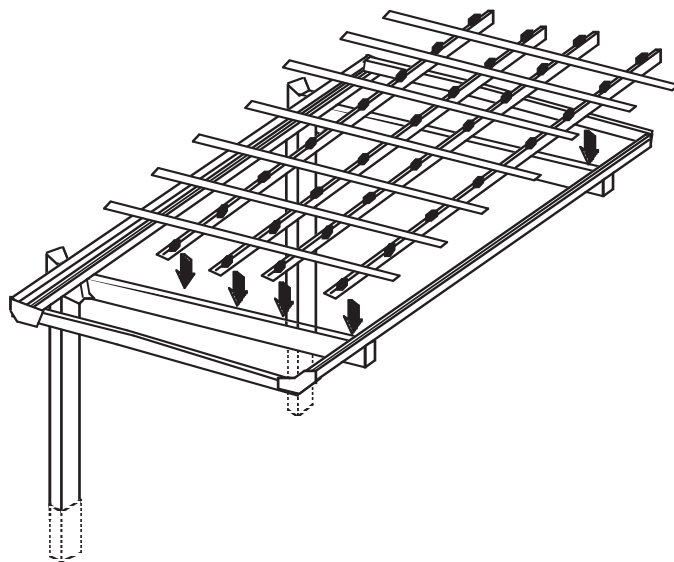

**Gutter - Side Frames - Front Frame - Main Frames - and Bottom Roof Rafters**

4

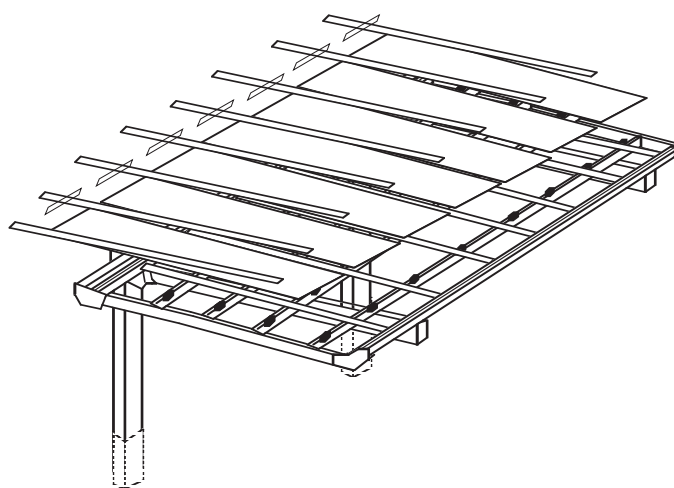

**Polycarbonate Roof Panels - Roof Panel Holders - Top Roof Rafter Strips**

**Post Set Out Measurements**

- Length 2.2m posts centered 1900mm
- Length 2.9m posts centered 2400mm
- Length 4.3m posts centered 2600mm
- Length 5.1m posts centered 2900mm
- Length 5.8m posts centered 3300mm



VR series only

## ALUMINIUM COLOR

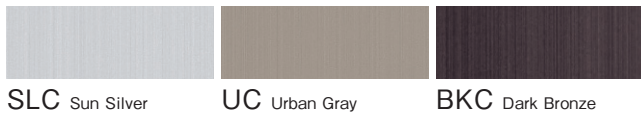

## STRENGTH



## ROOF COLOR

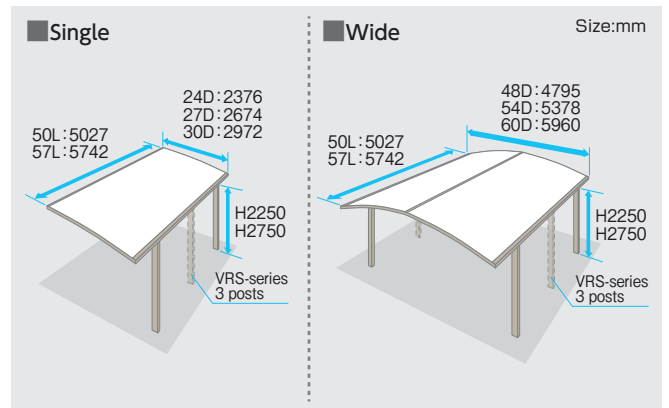
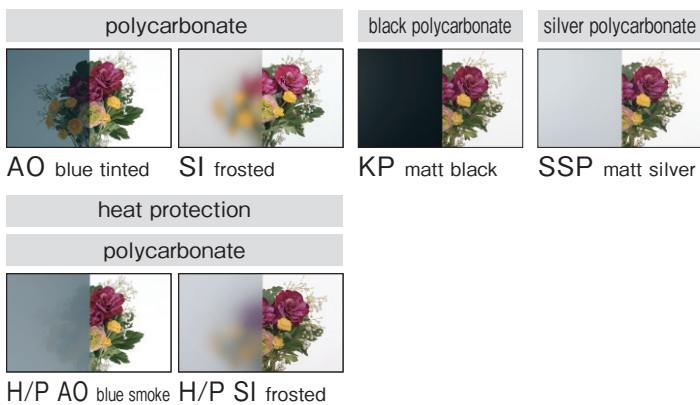



### Single side panel type

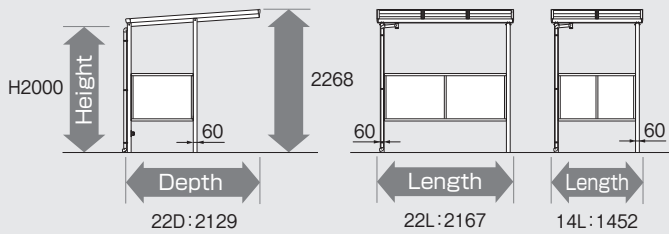

### Double side panel type

Size:mm

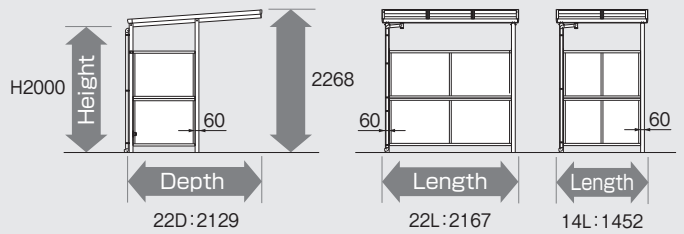

### ALUMINIUM COLOR

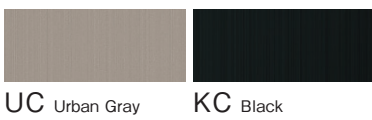

UC Urban Gray

KC Black

### ROOF COLOR



SI frosted

H/P SI frosted

### Middle post type

Single side panel



Double side panel



### End post type

Single side panel



Double side panel



Single side panel



Double side panel



Single side panel



Double side panel





## ALUMINIUM COLOR

aluminium type



SLC Sun Silver UC Urban Gray BD Dark Bronze



KC Black WH White

## CEILING COLOR



FA Trad Oak YC Craft Cherry HG Bitter Grain

## SIDE PANEL



## ROOF FRAME

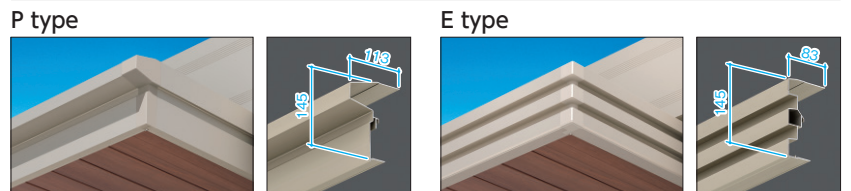



Multi-purpose



DIMENSIONS

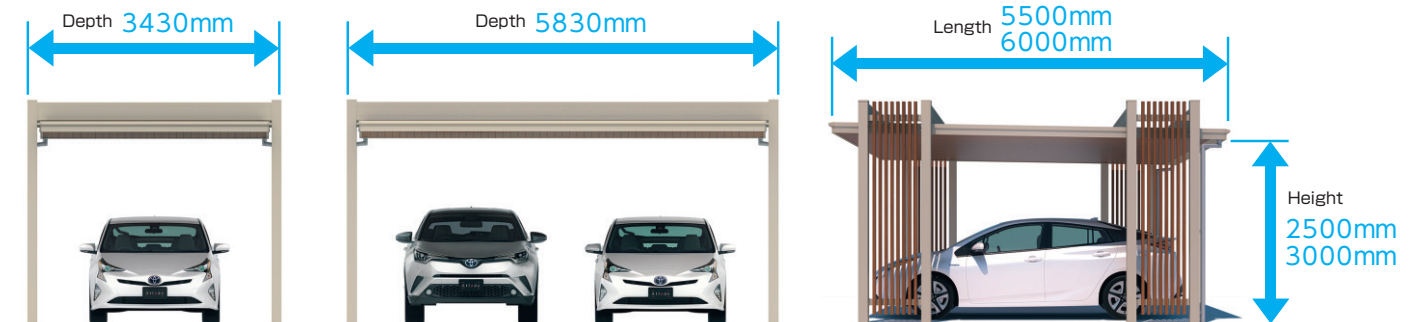



ALUMINIUM COLOR / CEILING

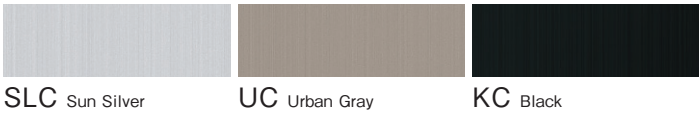

ROOF COLOR      SIDE PANEL

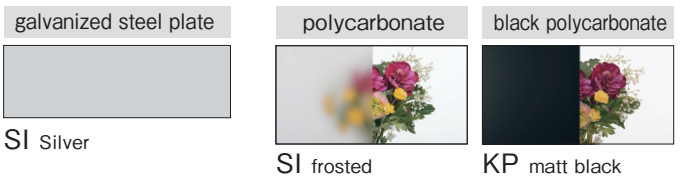

STRENGTH





## TYPE

### Standard Type (without ceiling)

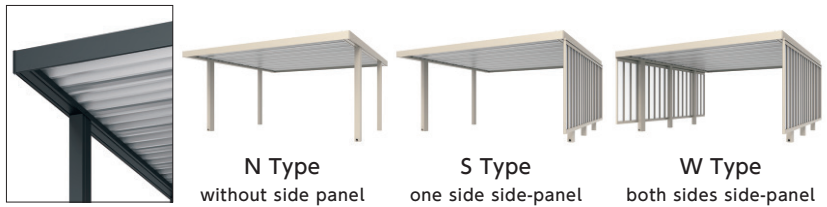

### Premium Type (with ceiling)

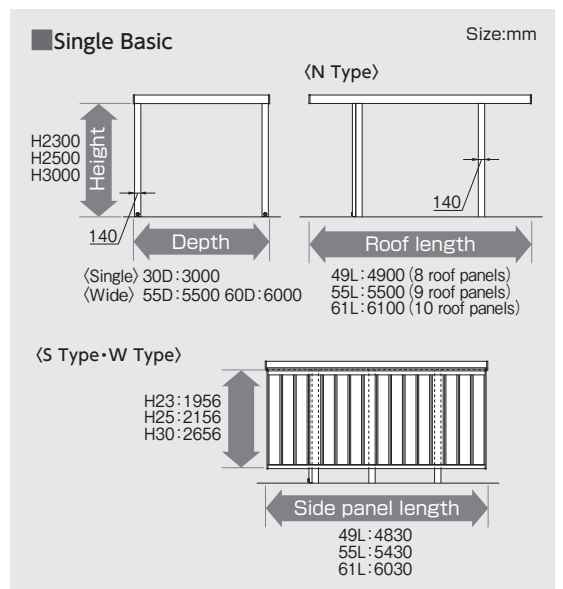
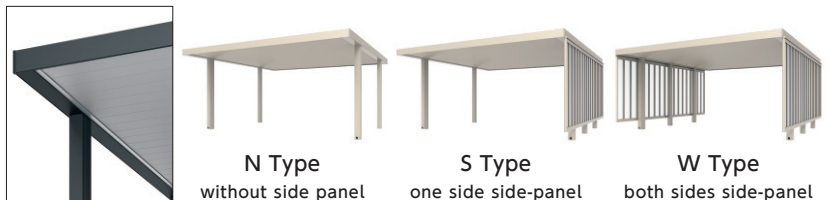

## Silver & Black Polycarbonate

### Silver Polycarbonate



SSP matt silver

### Black Polycarbonate



KP matt black

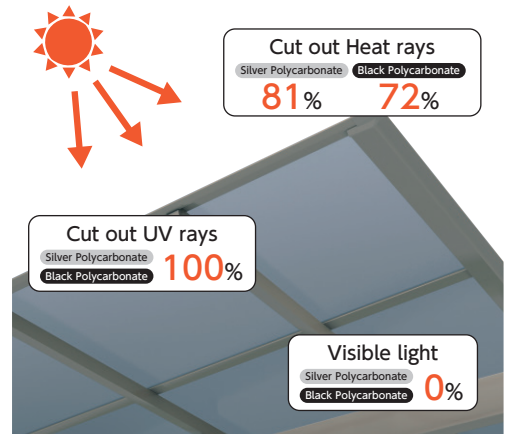

## Heat Protection Polycarbonate



H/P AO blue smoke

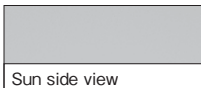

Sun side view



Ground side view

When looking from the sun side, the surface reflects in sunlight, therefore the color of the panel looks different from the ground side view.



**Cuts out 83% of heat rays**

Almost all harmful ultraviolet rays (UV) can be cut out. The roof protects car paintwork from fading and car seats from discoloring.

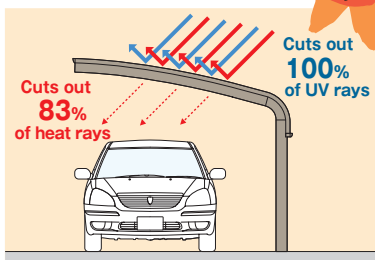

The temperature in sun-heated cars can rise to 65.8°C. Heat protection polycarbonate carports protect your cars from the summer heat.

**CAR INSIDE -21°C**

Polycarbonate roof protects your car from heat waves and restricts temperature rise in the car.

■ Effect of polycarbonate roof against heat wave (our test result)

Exposed to the sun	Under general polycarbonate roof	Under heat protection polycarbonate roof
65.8°C	50.5°C	44.1°C

The above values are actual values measured by us and not guaranteed values for the products.







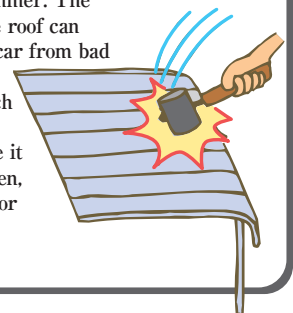

**Approx. 250 times stronger than glass**

Polycarbonate sheet has impact resistance approx. 250 times higher than glass.

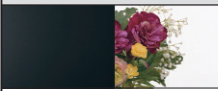
It can even withstand being hit with a hammer. The polycarbonate roof can protect your car from bad weather conditions such as hail. In addition, since it does not harden, it is suitable for use in cold climates.

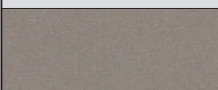
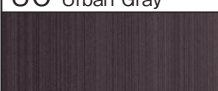

Model	MSD MSK	USN	KWC	LJ	MLR	RSC	PJFF	PJR	PJF	VR VRS	KLB KLBS	ATLD	SKC
<b>Polycarbonate</b> Cut out UV rays 100% and has a strong impact resistance 250 times higher than glass. Since it does not harden at low temperatures, it is suitable for use in cold climates.													
				●	●			●	●	●			
AO blue tinted													
	●	●	●	●	●	●	●	●	●	●	●	●	●
SI frosted												Side panel	Side panel
<b>Silver polycarbonate</b> Non-transparent, matt silver polycarbonate. It combines heat-shielding and light-blocking properties.													
			●	●	●		●	●	●	●			
SSP matt silver													
<b>Black polycarbonate</b> Non-transparent black polycarbonate suppress the rise in temperature inside the car.													
			●	●	●		●	●	●	●			●
KP matt black													Side panel
<b>Heat absorb polycarbonate</b> The panel absorbs solar heat rays (infrared rays) and cut out UV rays 100%.													
	●												
CL clear													
<b>Heat protection polycarbonate</b> The panel effectively cuts solar heat rays (infrared rays) and UV rays.													
		●	●	●	●	●		●	●	●			
H/P AO blue smoke													
	●	●	●	●	●	●	●	●	●	●	●		
H/P SI frosted													
<b>Aluminium roof panel</b> Aluminum alloy panels protect the car from direct sunlight and solar heat. Both surfaces are coated with a polyester resin baked-on coating.													
		●						●	●				
UC Urban Gray													
		●						●	●				
BD Dark Bronze													

## Roof Panel Performance

Panel Type \ Performance	Polycarbonate		Black Polycarbonate	Silver Polycarbonate	Heat Protection Polycarbonate	
	Blue Tinted (A0)	Frosted (SI)	Matt Black (KP)	Matt Silver (SSP)	Blue Smoke (H/P A0)	Frosted (H/P SI)
Heat Rays (IR) Cut %	40%	16%	72%	81%	83%	70%
Visible Rays Transmissivity %	20%	88%	0%	0%	11%	76%
UV Rays Cut %	100%	100%	100%	100%	100%	100%

## Heat Effect under the Sun Shine

Panel Type \ Performance	Sun Direct	Polycarbonate (BR)	Black Polycarbonate	Heat Protection Polycarbonate (H/P A0)
Car inside	65.8°C	50.5°C	44.4°C	44.1°C
Steering wheel (surface)	85.6°C	60.4°C	44.6°C	48.2°C
Dashboard (surface)	92.7°C	66.5°C	45.2°C	50.4°C

Test Condition : JAPAN / Summer / Fine Day  
Ambient Temperature : 34°C~36°C



Outdoor Living



## TF Series

Flat: 3 different types are available.

Fixed Post Type

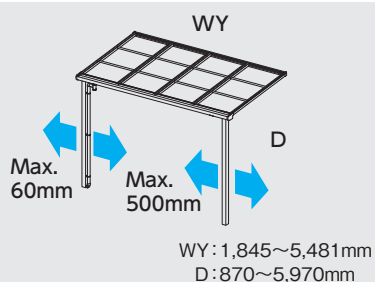

Adjustable Post Type

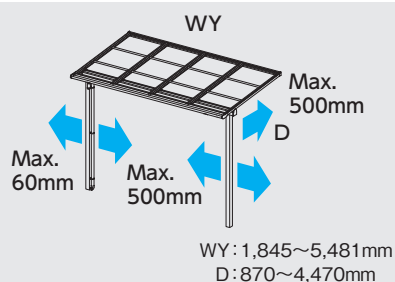
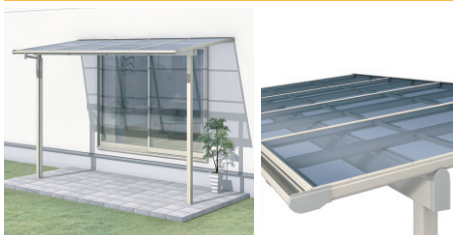

Bracket Type

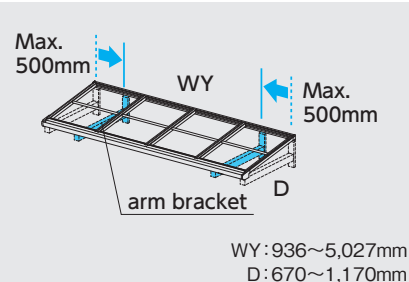

## TR Series

Curve: 3 different types are available.

Fixed Post Type

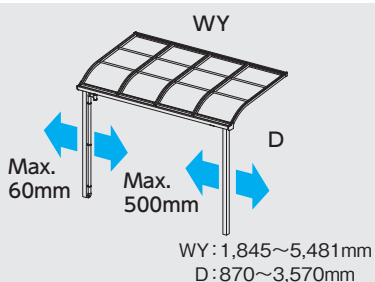

Adjustable Post Type

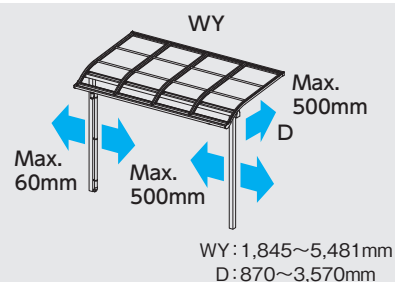
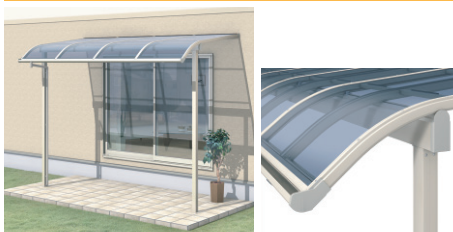

Bracket Type

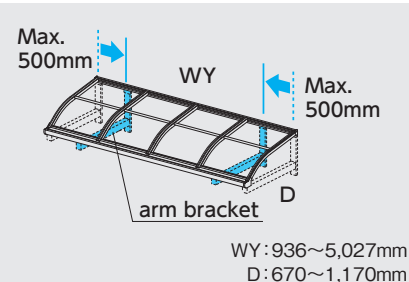
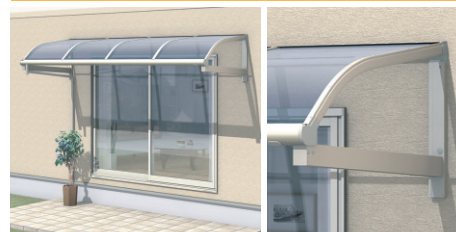

## ALUMINIUM COLOR



SLC Sun Silver

UC Urban Gray

BKC Dark Bronze

KC Black

WH White

BR Bronze

## ROOF COLOR



BR brown tinted

AO blue tinted

SI frosted

KP matt black

H/P SI frosted

CL clear



Installation Examples





PREMIUM

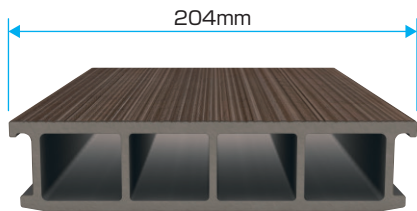

TEB



EBR



ASN

ALUMINUM BASIC STRUCTURE

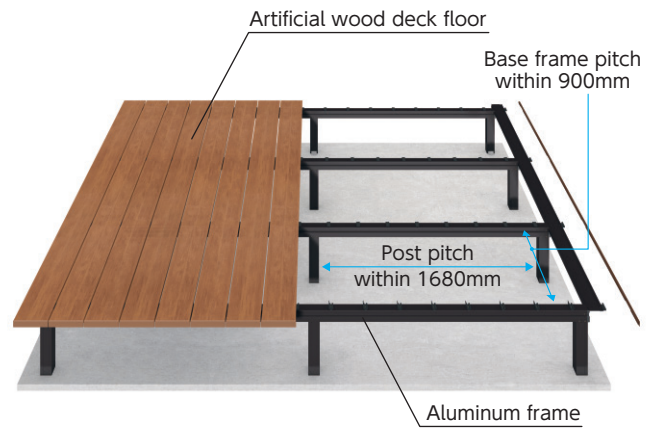

STANDARD

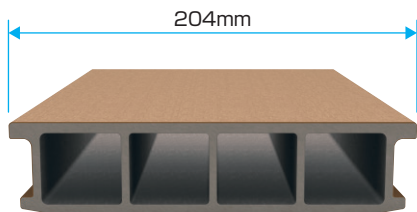

MWB



MRO

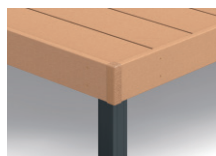

WBR

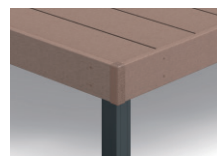

RO

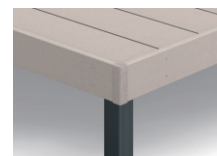

SAG

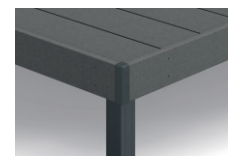

CY



Outdoor Frame  
L-class



UC



KC

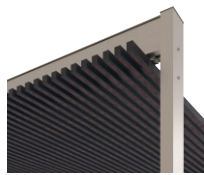

UC Frame FA Screen

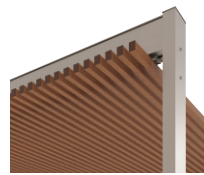

UC Frame YC Screen

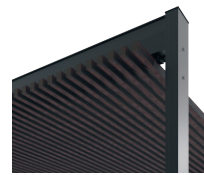

KC Frame FA Screen

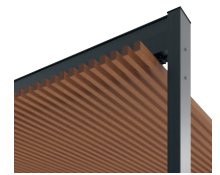

KC Frame YC Screen

FRAME COLOR



UC Urban Gray

KC Black

TYPE

TN 18 x 30

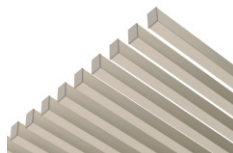

UC Urban Gray

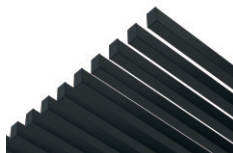

KC Black

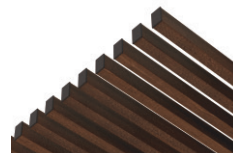

FA Trad Oak



YC Craft Cherry

TK 35 x 50

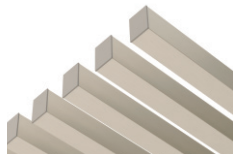
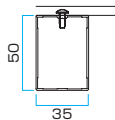
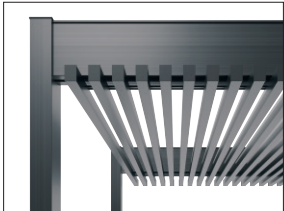

UC Urban Gray



KC Black

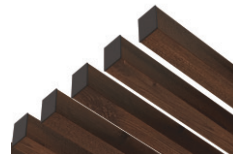

FA Trad Oak



YC Craft Cherry

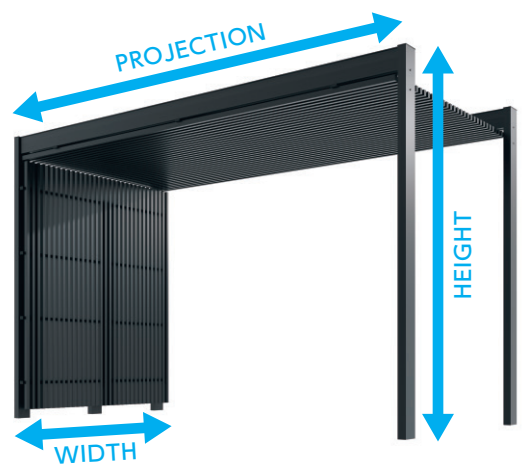

## VERTICAL

Size:mm

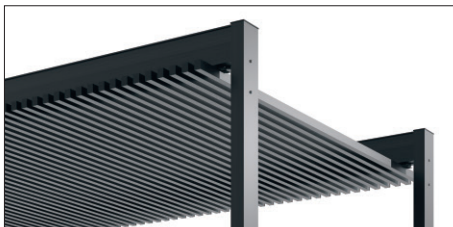

VERTICAL SLATS	PROJECTION x WIDTH x HEIGHT (Depth of Beam with posts)								
PROJECTION	1800	3000	4800	5400	6000				
WIDTH	3200	3800	4400	5000	6000	6200	7100	8000	
HEIGHT	2600	3000							

## PARALLEL

Size:mm



PARALLEL SLATS	PROJECTION x WIDTH x HEIGHT (Depth of Beam with posts)							
PROJECTION	1200	1800	2400	3000				
WIDTH	3200	3800	4400	5000	6000	6200		
HEIGHT	2600	3000						



## Gate & Fence



AGT-1



KA/0818

AGT-2



KA/0818

AGT-3

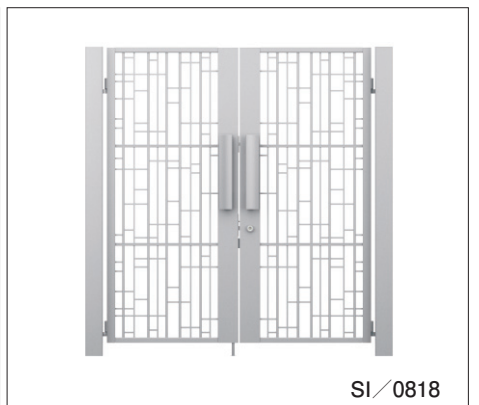

SI/0818

ALUMINIUM COLOR



SI Silver

KA Art Black

Dimension (mm)

H \ W	800	900	1150
1600	○	○	○
1800	○	○	○
2000	○	○	—

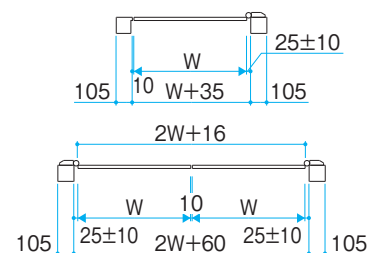

# MCE series



## ALUMINIUM COLOR

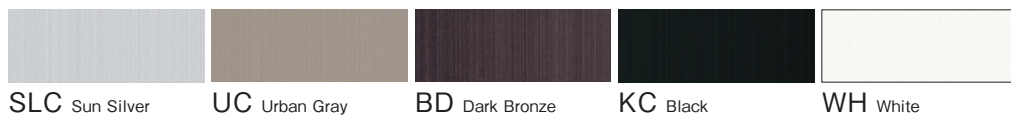

### Single Gate

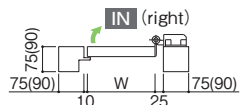

### Double Gate

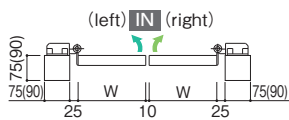

( ) indicates H:1600 or higher.

## Dimensions (mm)

	Height	Width									
		Single Gate					Double Gate				
		600	700	800	900	1000	600×2	700×2	800×2	900×2	1000×2
1000	○	○	○	○	—	○	○	○	○	—	
1200	○	○	○	○	○	○	○	○	○	○	
1400	—	○	○	○	○	—	○	○	○	○	

## OPEN-OUT installation

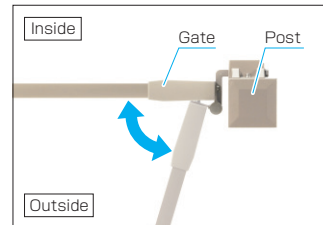

**Maximum Height is 2m (6.5ft) .  
Maximum Width is 2.2m (7.2ft)  
(for Double Gate)**



**ALUMINIUM COLOR**

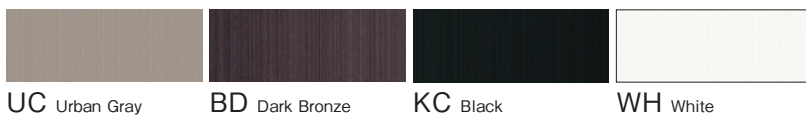

**Dimensions (mm)**

		Width							
		Single Gate				Double Gate			
		800	900	1000	1100	800×2	900×2	1000×2	1100×2
Height	1600	○	○	○	○*	○	○	○	○*
	1700	○	○	○	○	○	○	○	○
	1800	○	○	○	○	○	○	○	○
	1900	○	○	○	○	○	○	○	○
	2000	○	○	○	○*	○	○	○	○*

\* indicates keyless entry lock gate size.

**H Type**

- Bar Handle: MJN-CT (Thumb Turn)



- Touch Handle: MJNT-CT (Thumb Turn)
- Touch Handle: MJNT-CC (Dimple Key)



- Touch Bar Handle: MJNG-CT (Thumb Turn)



**HM Type**

- Lever Handle: LMN-01 (Thumb Turn)
- Lever Handle: LMN-03 (Cylinder Key)
- Lever Handle: LMN-04 (Dummy Cylinder Key)



**HK Type**

- Keyless Entry Lock: MJN-KX-S





Y1 / FAC / 0712 Double Gate



## ALUMINIUM COLOR

laminate type								aluminum type only	
FA Trad Oak	SLC Sun Silver	YC Craft Cherry	SLC Sun Silver	FA Trad Oak	UC Urban Gray	YC Craft Cherry	UC Urban Gray	UC Urban Gray	BD Dark Bronze
FAL		YCL		FAU		YCU			
FA Trad Oak	BD Dark Bronze	HG Bitter Grain	KC Black	YN Silky Noche	KC Black				
FAC		HGK		YNK					
FA Trad Oak	YC Craft Cherry	YN Silky Noche							

※The standard color changes depending on the panel design. Please contact us for details.

### OPEN-OUT installation

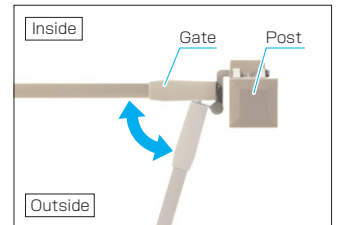

### Single Gate

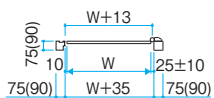

### Double Gate

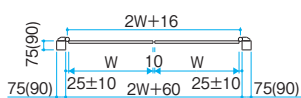

### Dimension (mm)

H \ W	700	800	900
1200	○	○	○
1400	○	○	○
1600	—	○	○

( ) indicates H:1600 or higher.

**Maximum Height is 2m (6.5ft) .  
Maximum Width is 2.2m (7.2ft)  
(for Double Gate)**

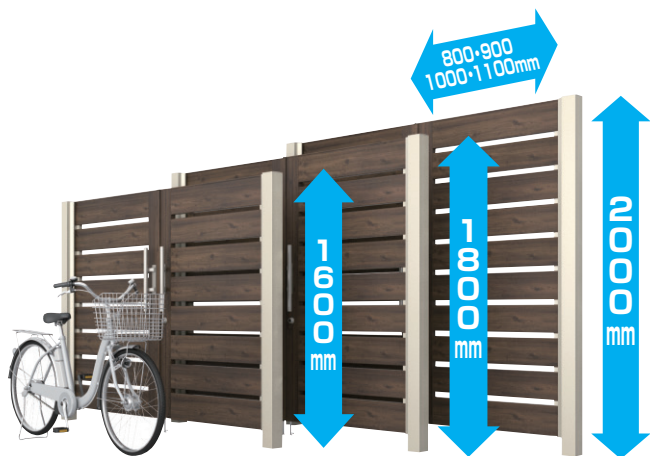

## ALUMINIUM COLOR

laminated type

FA Trad Oak	SLC Sun Silver	FA Trad Oak	UC Urban Gray	YC Craft Cherry	UC Urban Gray	FA Trad Oak	BD Dark Bronze
FAL		FAU		YCU		FAC	

aluminum type only

UC Urban Gray	BD Dark Bronze
------------------	-------------------

### H Type

- Latch Handle  
LWU-01 (Thumb-turn)
- Touch Handle  
LWT-01 (Thumb-turn)  
LWT-02 (Dimple Key)
- Touch Bar Handle  
LWT-B01 (Thumb-turn)  
LWT-B02 (Dimple Key)

### HM Type

- Lever Handle:  
LMN-01 (Thumb Turn)
- Lever Handle:  
LMN-03 (Cylinder Key)
- Lever Handle:  
LMN-04 (Dummy Cylinder Key)

### Dimensions (mm)

H \ W	800	900	1000	1100
1600	○	○	○	○
1800	○	○	○	○
2000	○	○	○	○

# CEF series



YK1



## ALUMINIUM COLOR



SLC Sun Silver

UC Urban Gray

BD Dark Bronze

KC Black

WH White

## Corner Connector



Rounded Lattice Type

Wing Lattice Type

Corner Joint

## In-Between Post Corner



Corner Post

## Free Post Type



## In-Between Post



Many combinations of fence panel heights are available.  
Maximum height is 2936mm (9.6ft).

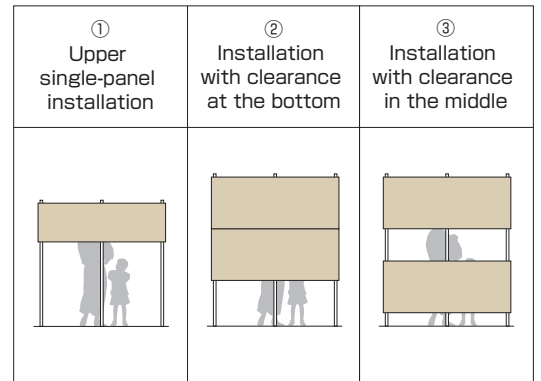

The fence panels can be installed at any height with adjustable brackets. You can combine different panel style and heights.



Top/bottom: YL2



Top/Middle: TM1/Under: TK1

### ALUMINIUM COLOR

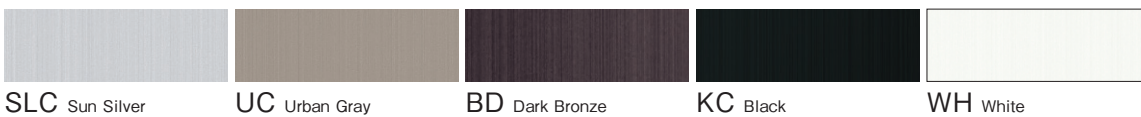

SLC Sun Silver

UC Urban Gray

BD Dark Bronze

KC Black

WH White

### Basic Combination Size (mm)

	12	14	16	18	20	22	24	26	28	30	
Height	1123	1323	1523	1723	1923	2123	2323	2444	2644	2844	



PANEL DESIGN

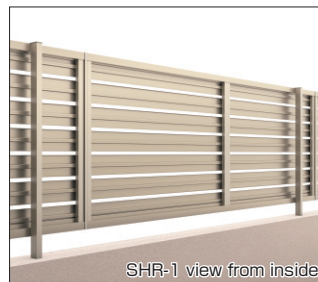
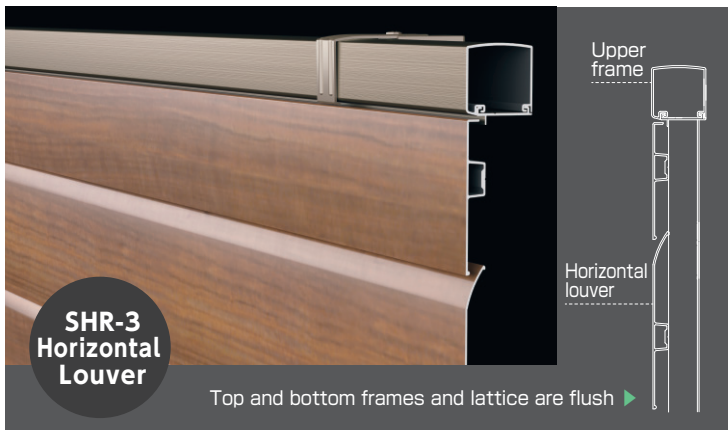

The horizontal flat can be selected from one-sided or two-sided wooden lattice.

ALUMINIUM COLOR

laminated type

FA Trad Oak	UC Urban Gray	YC Craft Cherry	UC Urban Gray	NE Cinnamon Elm	UC Urban Gray	FA Trad Oak	KC Black	YC Craft Cherry	KC Black	NE Cinnamon Elm	KC Black	JN Smoke Nut	KC Black
FAU	YCU	NEU	FAK	YCK	NEK	JNK							

## Design Variations

SHR-1



Horizontal Flat (One-sided wooden style)

SHR-1S



Horizontal Flat Low Line (One-sided wooden style)

SHR-2



Horizontal Flat (Both-sided wooden style)

SHR-2S



Horizontal Flat Low Line (Both-sided wooden style)

SHR-3



Horizontal Louver

SHR-3S

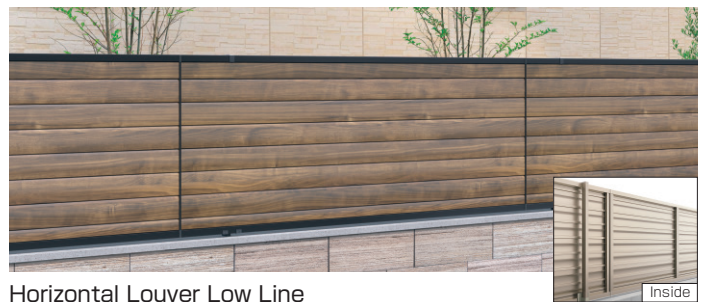

Horizontal Louver Low Line

SHR-5



Horizontal Thick

SHR-6



Vertical Flat

## Size Variations and Line-Up



( ) dimension indicates 15/25/35.

# ROF series



Max. height 3m

9 different heights from 600mm to 3000mm.

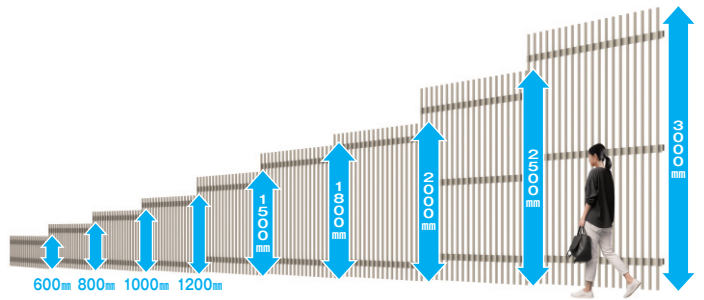

※ Heights 600mm and 800mm are from Type1 to Type3.  
 ※ 2500mm is Type1 and Type6 only.  
 ※ 3000mm is Type1 only.

<p>Type 1 (Picket pitch 100mm)</p> <p>Square</p>	<p>Type 2 (Picket pitch 125mm)</p> <p>Square</p>	<p>Type 3 (Picket pitch 62.5mm)</p> <p>Square</p>	<p>Type 4 (Picket pitch 100mm)</p> <p>Sword tip</p>
<p>Type 5 (Picket pitch 100mm)</p> <p>Wood toon</p>	<p>Type 6 (Picket pitch 100mm)</p> <p>Curve top</p> <p>In-ward out-ward</p>	<p>ROMC-1</p>	<p>RKMC-1</p>

※Inward

# NLB series



Non-rail sliding gate

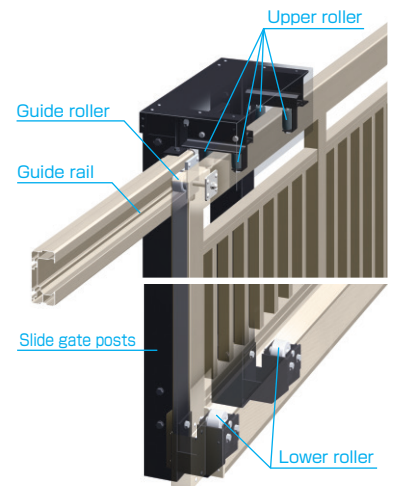

<p>Double-sided Cylinder Lock</p>	<p>Lock-Down Stick &amp; Wheel</p> <p>Wheel</p>	<p>Meet point</p>
-----------------------------------	---	-------------------

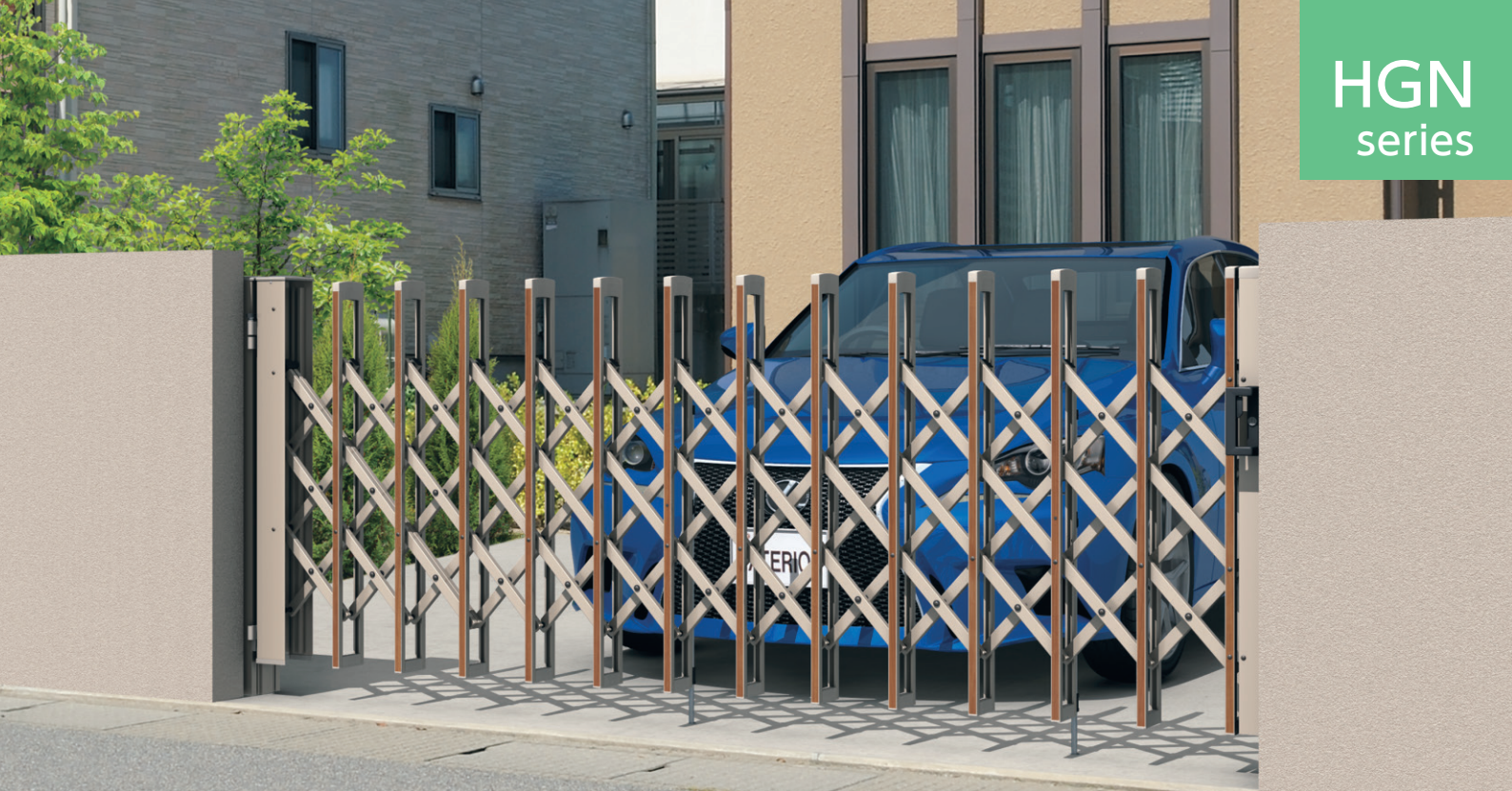

**Non-Caster Accordion gates need no tracks or slab adjustments.**

**Some Non-Caster Accordion gates can handle a slope up to 5°**

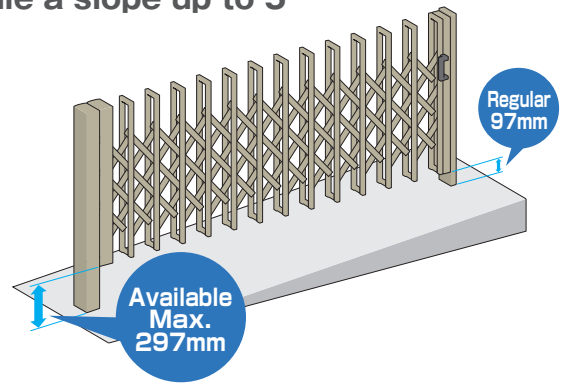
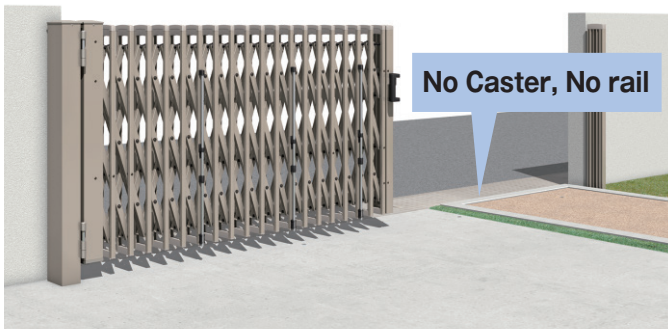

**The wider accordion gates (5m/16.4ft for single and 10m/32.8ft for double) have a recessed caster wheel.**

**Non Caster: W: 13~W: 43      Caster: W: 45~W: 49**

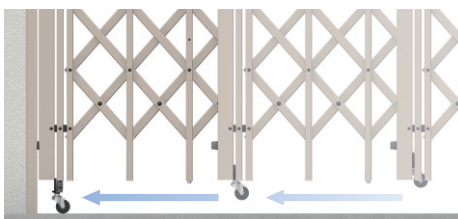

The caster wheel comes out when the gates is fully extended, to support the front end. Easy Docking when closing the gate.

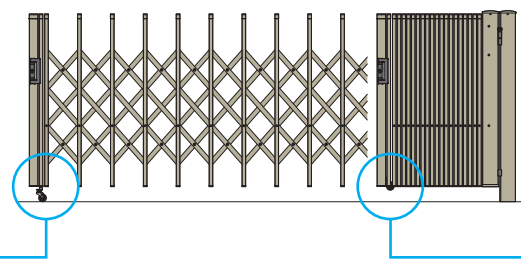

**ALUMINIUM COLOR**

aluminium type		
SLC Sun Silver	UC Urban Gray	BD Dark Bronze

lamine type			
FA Trad Oak	UC Urban Gray	YC Craft Cherry	UC Urban Gray
FAU		YCU	

**SIZE VARIATION**

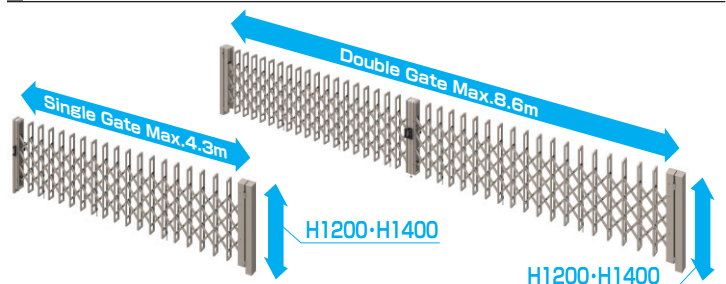





Color : NE  
H81 Ventilation door  
Window / up & down



Color : JC  
H11 Ventilation door  
Window / open-in



Color : BKC  
A20 Slit lighting door

The ventilation door lets natural breezes into the room even when the door is locked.



inside

inside



## Handle Type



# Innovative Carport FAK series

A new style carport with high design and functionality.



# XSC series

The combination of carport and screen creates a high-quality space with a variety of fit and high design.



# SCN series

Strong for stormy wind and heavy snow.



## Manufacturer:

**Sankyo Tateyama, Inc.**  
**SankyoAlumi-Company**

Exterior Business Division

Address: 70 Hayakawa, Takaoka, Toyama 933-8610, Japan

Homepage: <https://www.exteriorworld.jp/english/>



ISO 9001  
ISO 14001



JTCCM  
QS/EMCA  
RQ 2063, RE 0695

(Registration range) <https://www.exteriorworld.jp/english/>



## General sales agency:

**TOYO Boeki Co., Ltd.**

Address : 5-3-7 Fukushima, Fukushima-ku,  
Osaka 553-0003, Japan

Tel : +81-6-6452-3839

Fax : +81-6-6452-3827

E-mail : [eigyobu@toyoboeki.co.jp](mailto:eigyobu@toyoboeki.co.jp)

Homepage: <https://www.toyoboeki.co.jp>

<https://www.carport-japan.jp>



Catalog No.  
**STX1905A**

Printed in Japan

YP.26.04-100